

# Assembly Instructions

STEP 1

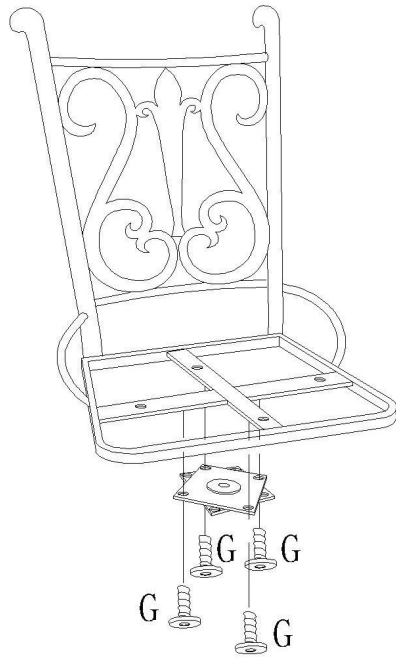

STEP 3

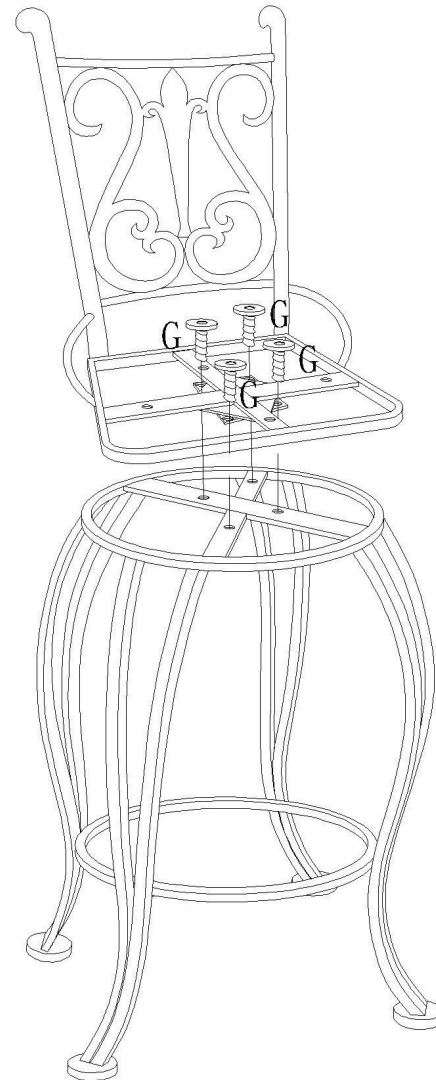



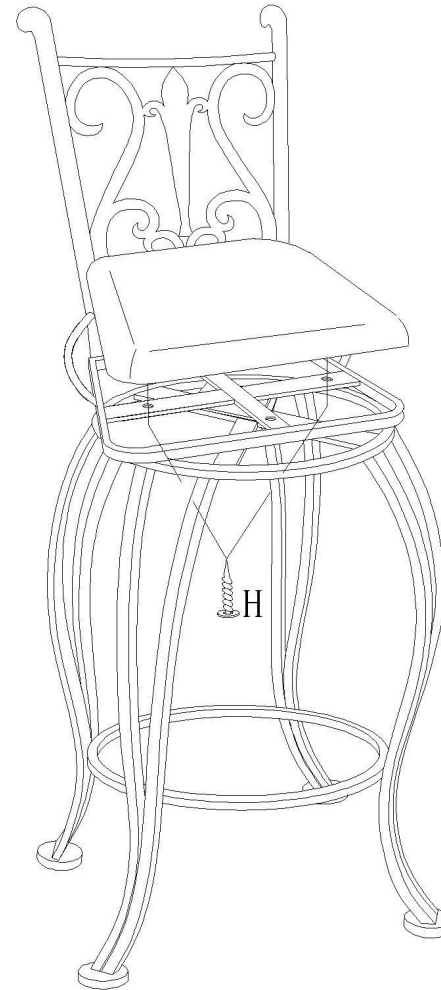



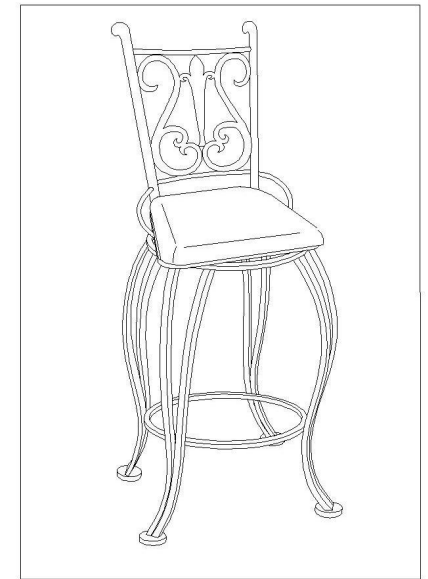
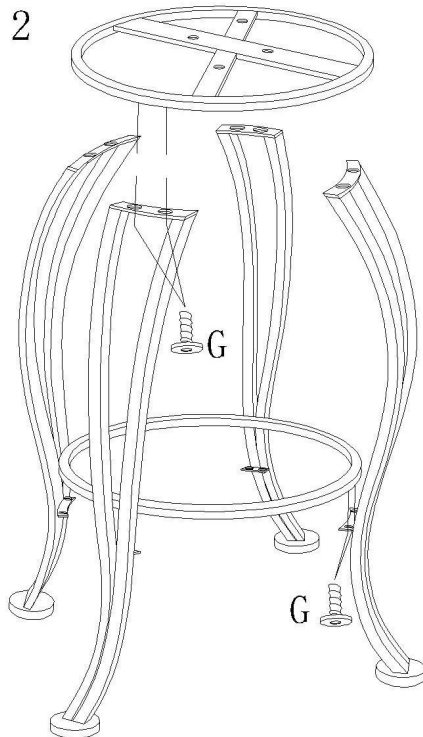

STEP 4

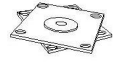

STEP 2



A		1 PC
B		1PC
C		4PCS
D		1PC
E		1 PC
F		1PC
G		24PCS
H		4PCS
I		1 PC