

Assembly Instruction

Model : WI5380

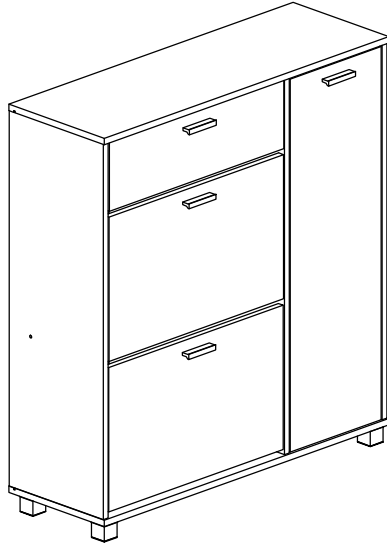

Part List

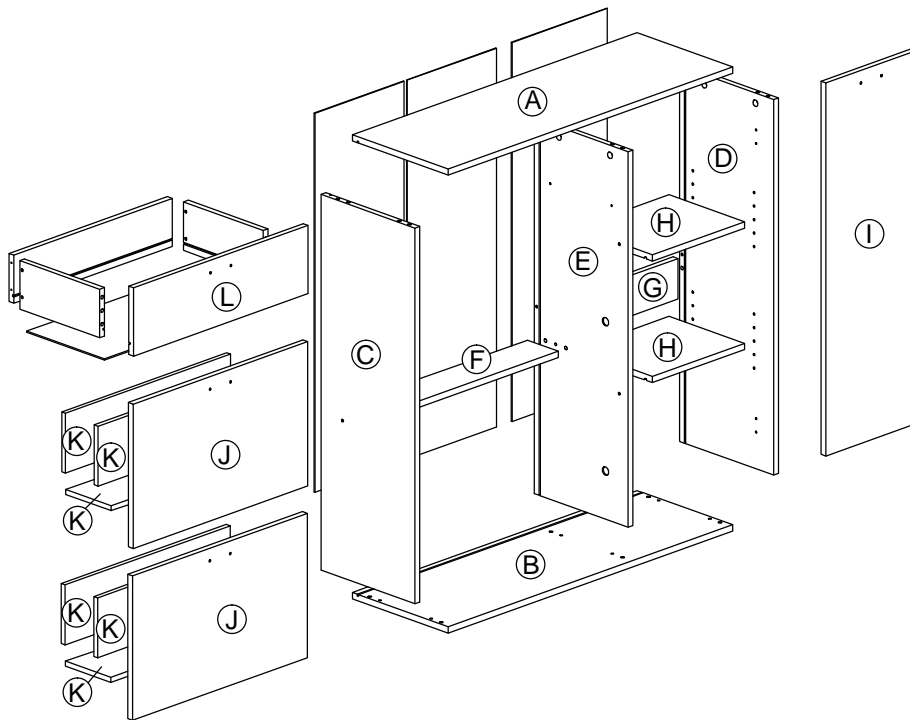

Assembly Instruction

Hardware List

No.	SHAPE	DESCRIPTION	Qty.
1		8x25mm Wood Dowel	24Pcs
2		15MM Titus Mini Fix	8Sets
3		Minifix Cap	4Pcs
4		Screw Cap	2Pcs
5		M3.5x15mm Screw	36Pcs
6		TP 10#x1/2" Screw	8Pcs
7		M4x38mm Screw	4Pcs
8		M5x38mm Screw	10Pcs
9		Nail	6Pcs
10		Shelf Support	8Pcs
11		Hinges (F010)	2Sets

12		Drawer Slide (250mm)	1Set
13		2 Pin Stopper	2Pcs
14		PVC Square Leg	5Pcs
15		M5x8mm Screw (Euro Screw)	4Pcs
16		Handle L Shape (84mm) M3.6x24mm Screw	4Sets
17		3 Tray Shoe Rack	2Sets
18		H Profile (890mm)	1Pc
19		M3.5x20mm Screw	4Pcs

Dowel / Cam - Lock Installation

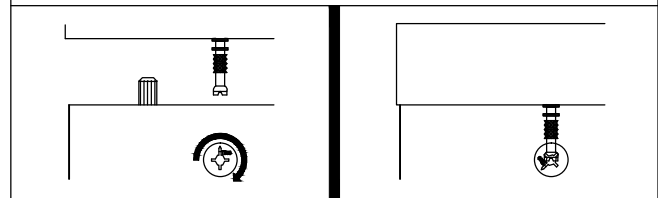

STEP 1

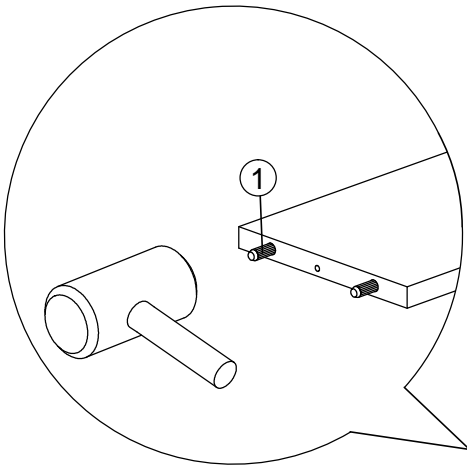

*Install all 8x25mm Wood Dowel into all panels as shown.

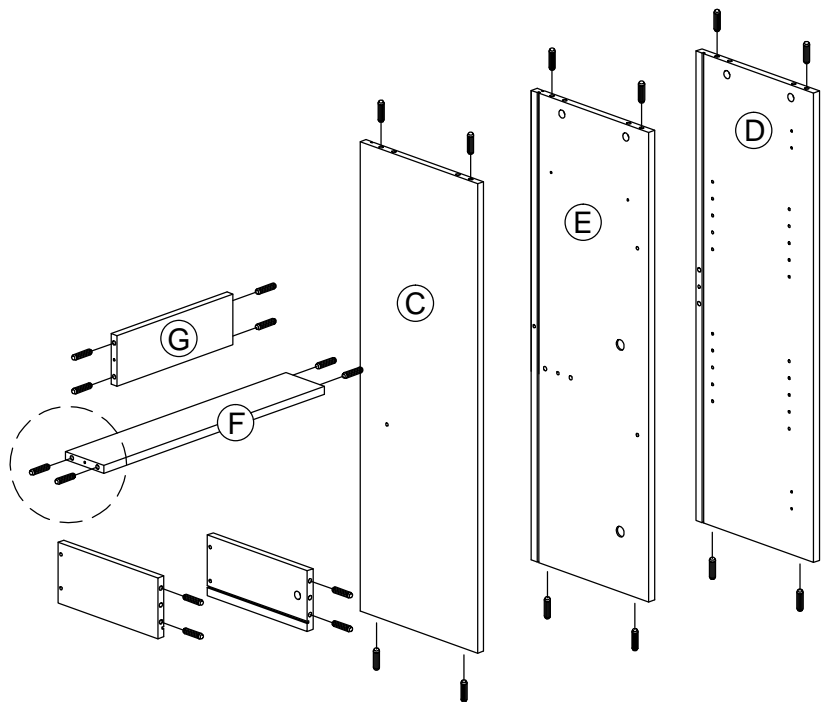

Assembly Instruction

STEP 2

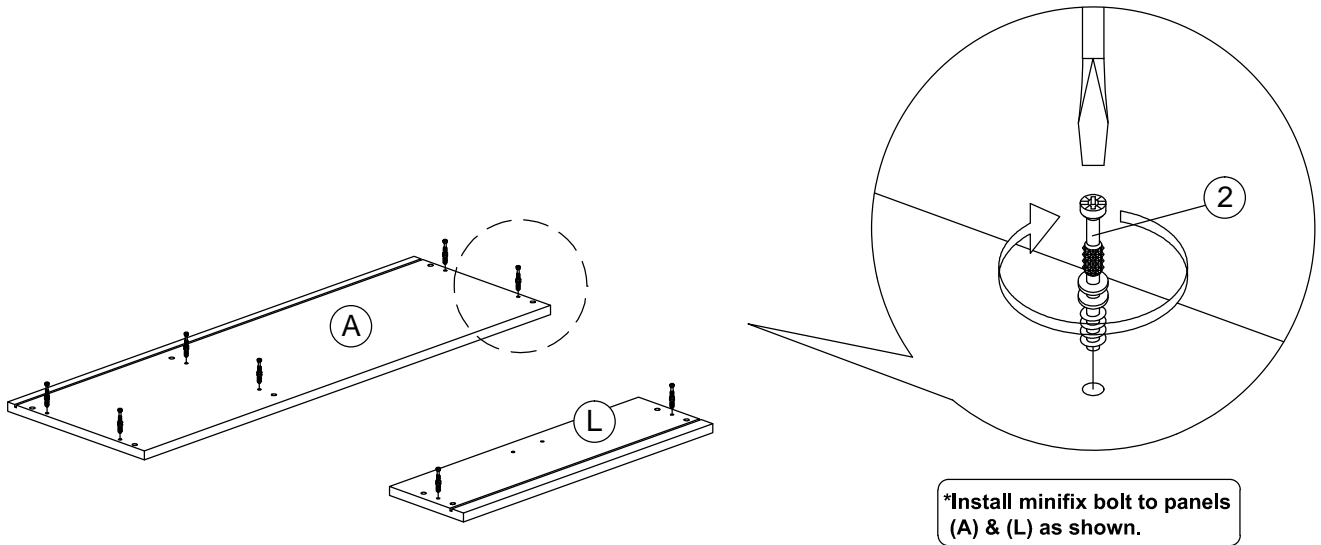

STEP 3

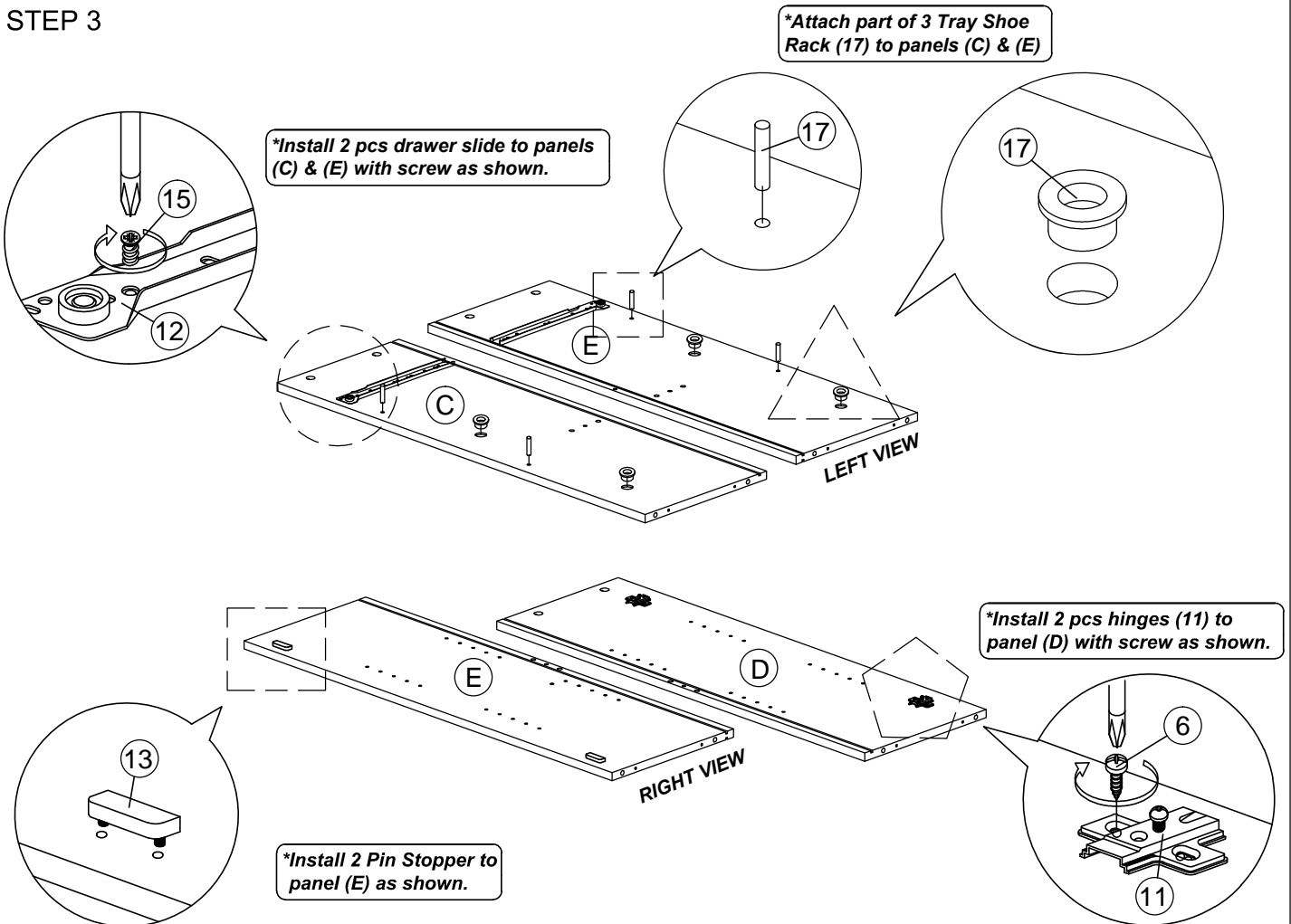

Assembly Instruction

STEP 4

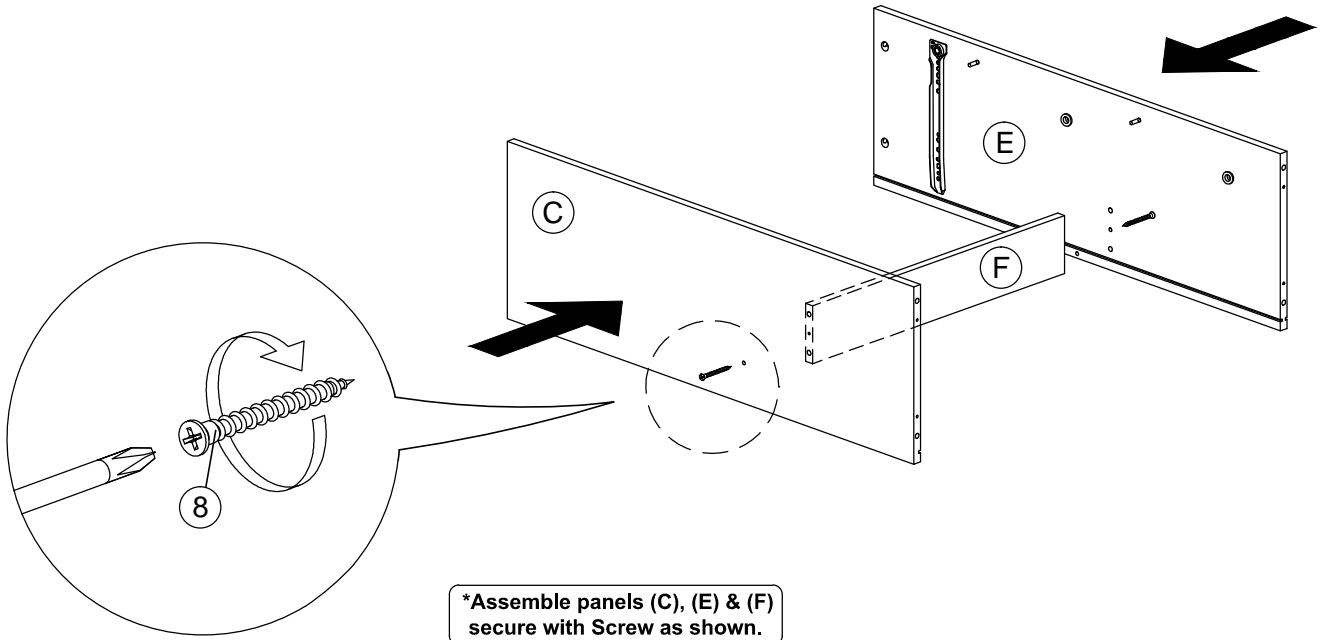

STEP 5

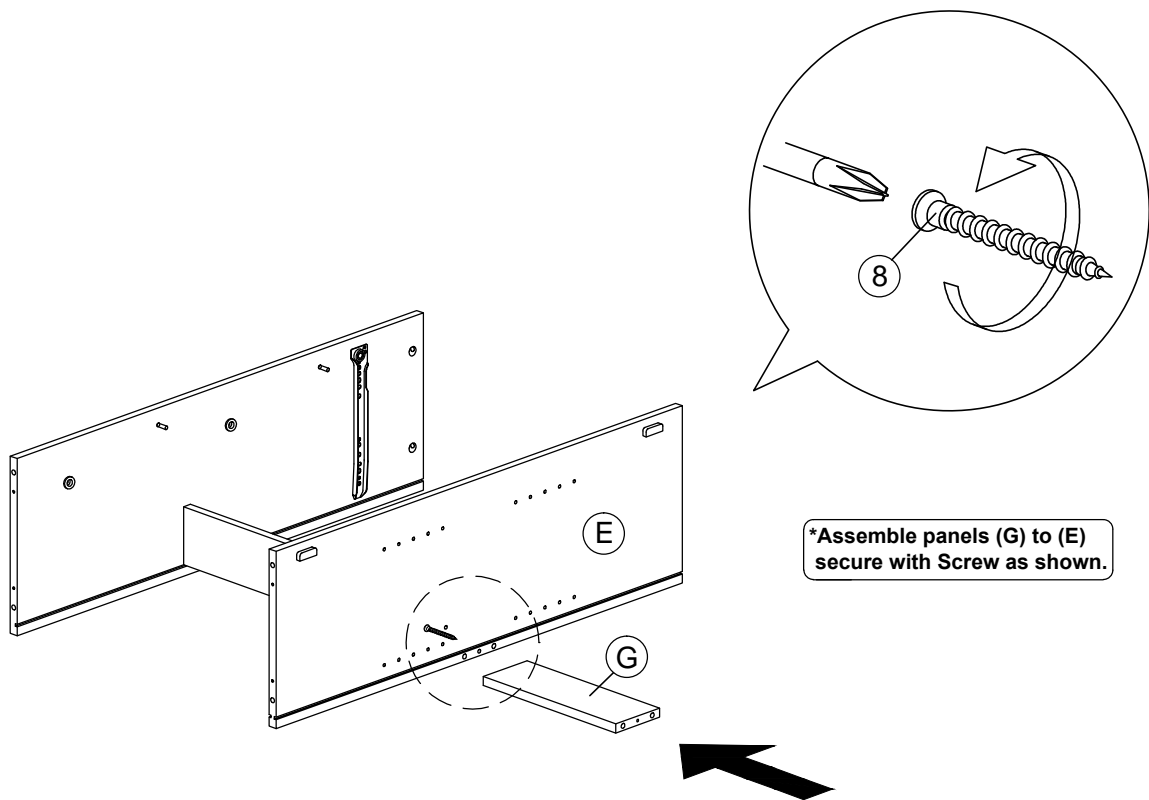

Assembly Instruction

STEP 6

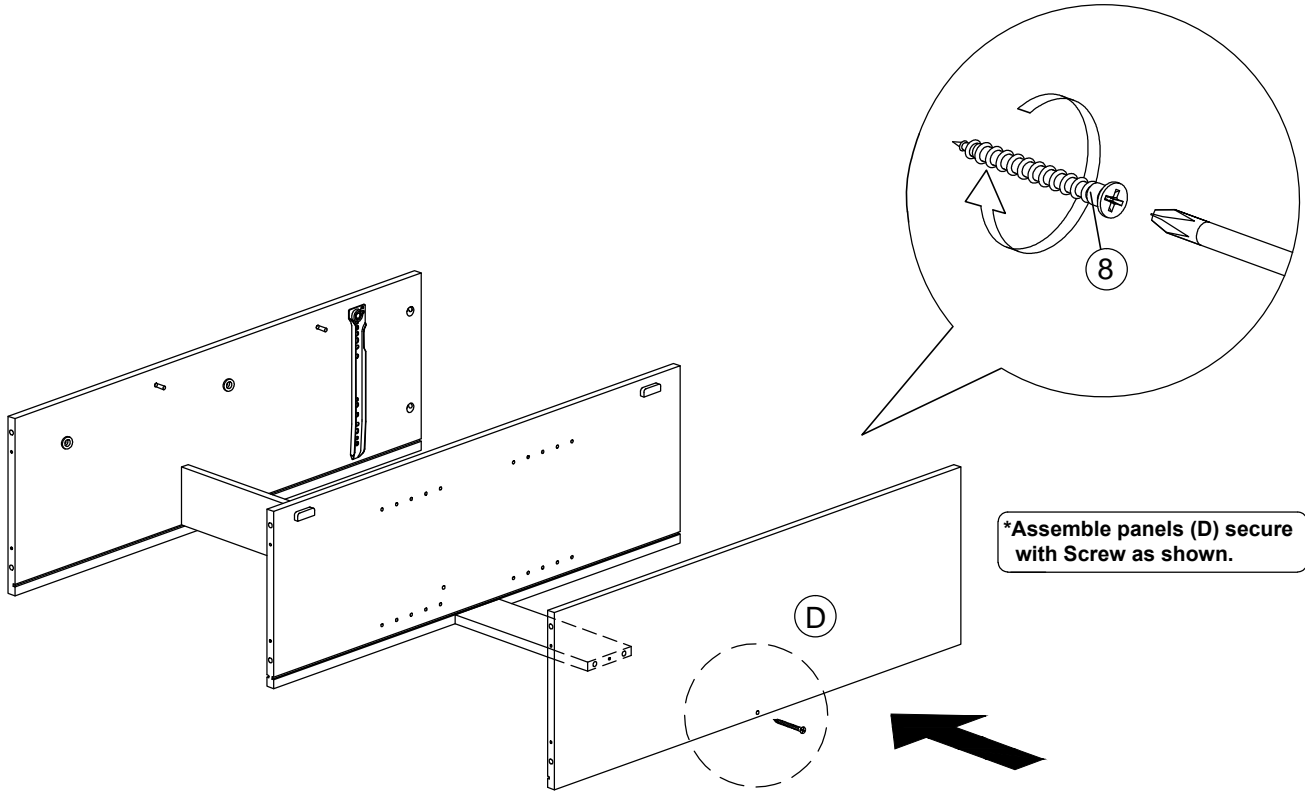

STEP 7

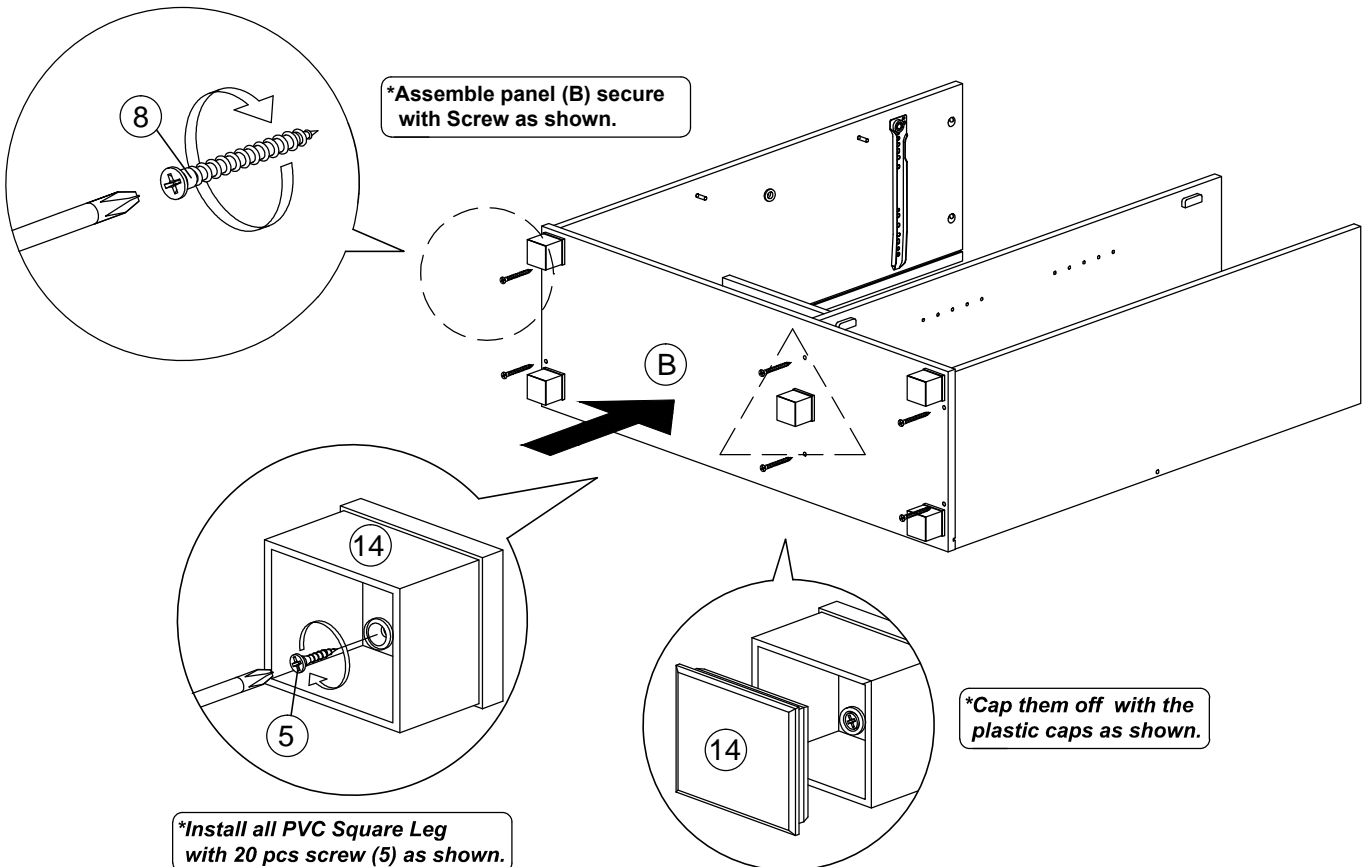

Assembly Instruction

STEP 8

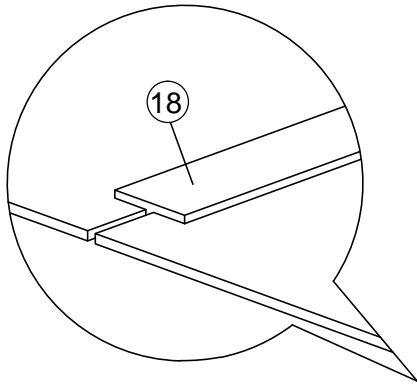

**Insert back panel as shown.*

**Secure back panel with Nail as shown below.*

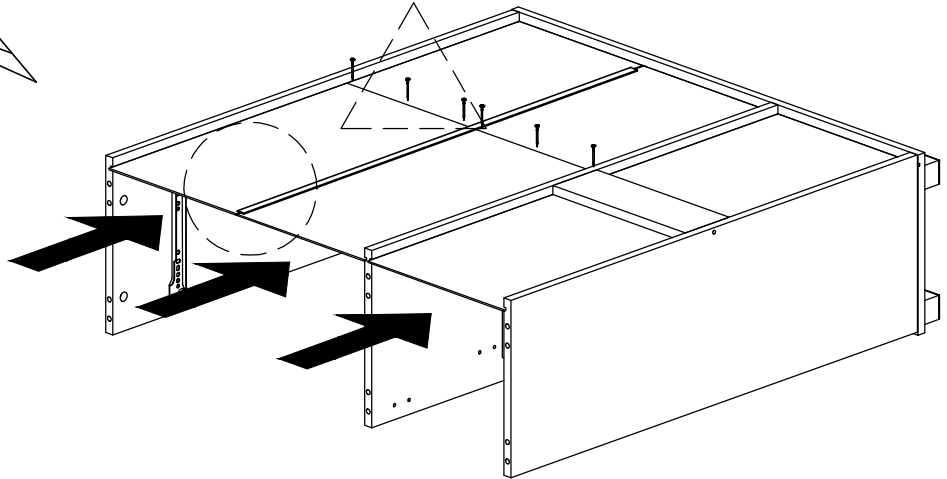
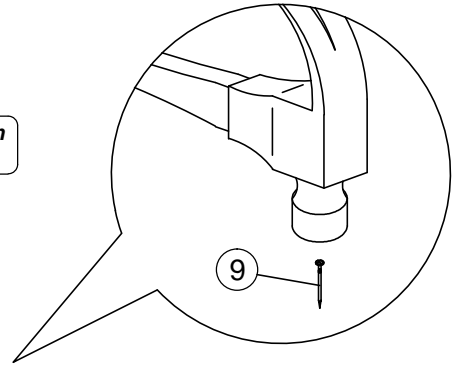

STEP 9

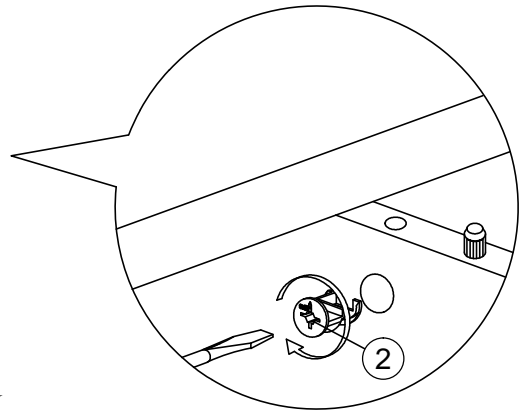
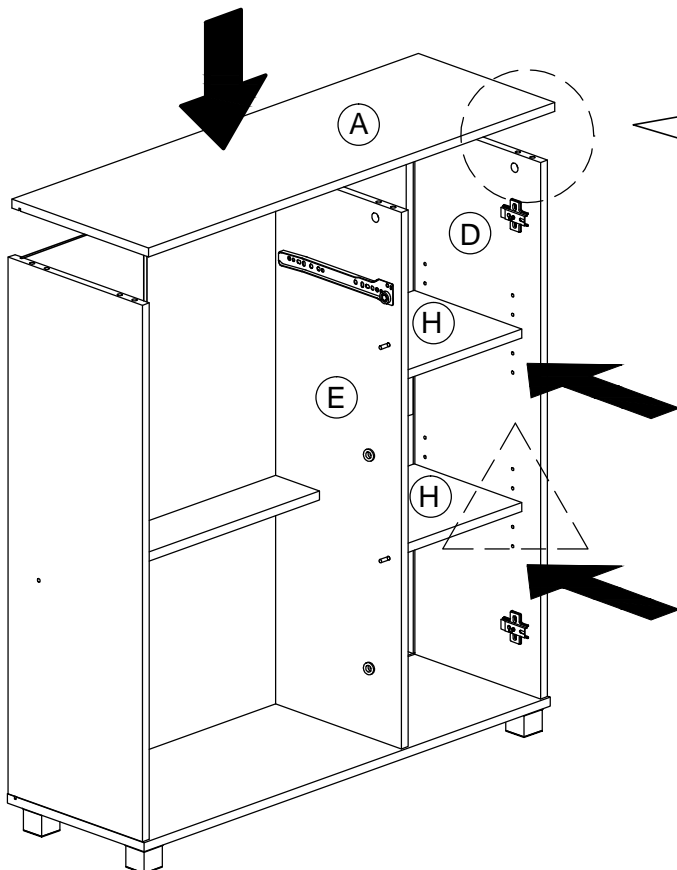

**Assemble Top Panel (A) secure with Minifix as shown.*

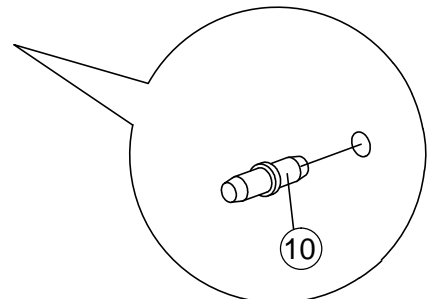

**Attach Shelf Support (10) to panels (D) & (E). Then insert panels (H) into cabinet as shown.*

Assembly Instruction

STEP 10

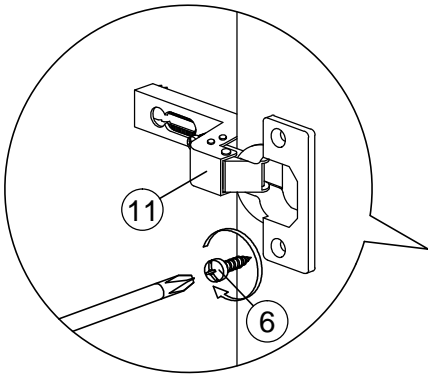

**Install 2 pcs Hinges with TP 10#x1/2" screw as shown.*

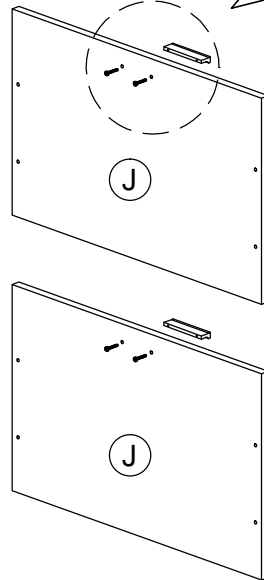
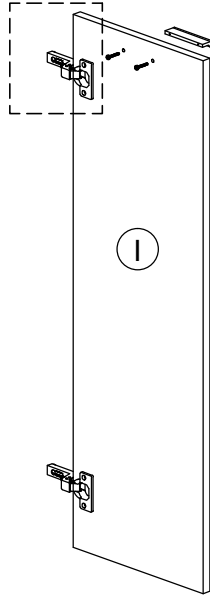

**Install Handle with screw as shown.*

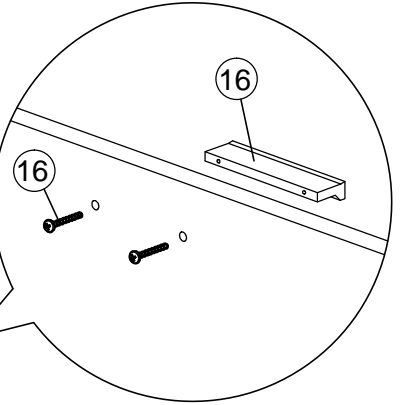

STEP 11

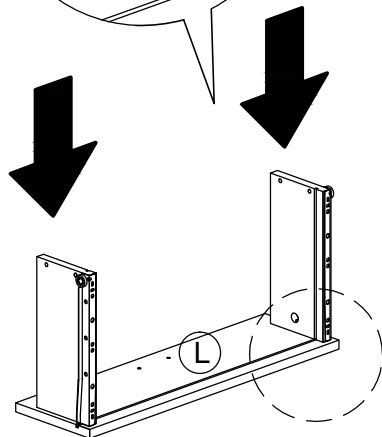
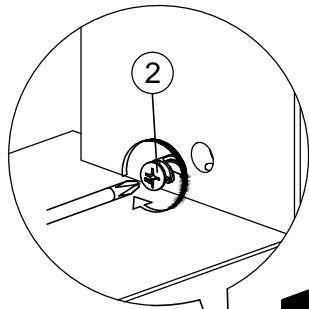

**Assemble drawer side panels secure with Minifix as shown.*

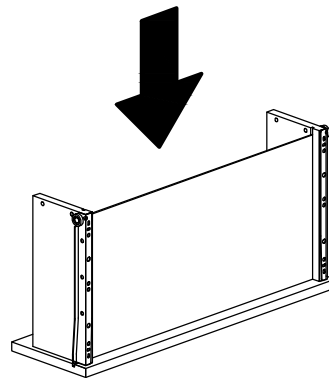

**Insert drawer bottom panel as shown.*

Assembly Instruction

STEP 12

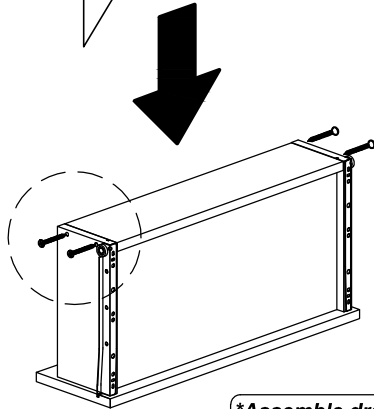
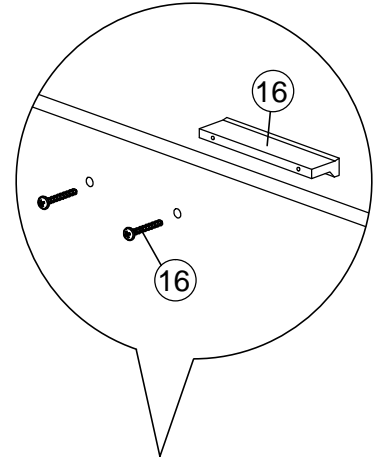
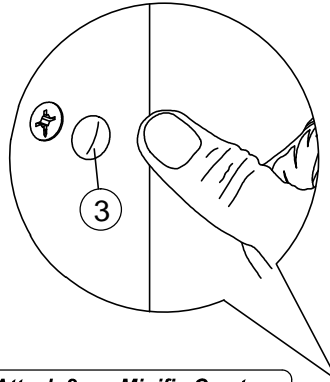
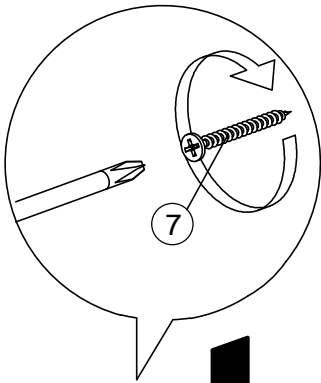

***Assemble drawer back panel, secure with screw as shown.**

***Attach 2pcs Minifix Cap to drawer side panels as shown.**

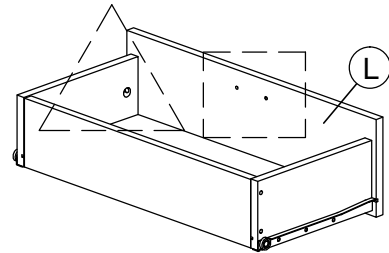

***Install Handle with screw as shown.**

STEP 13

***Insert the drawer into cabinet as shown.**

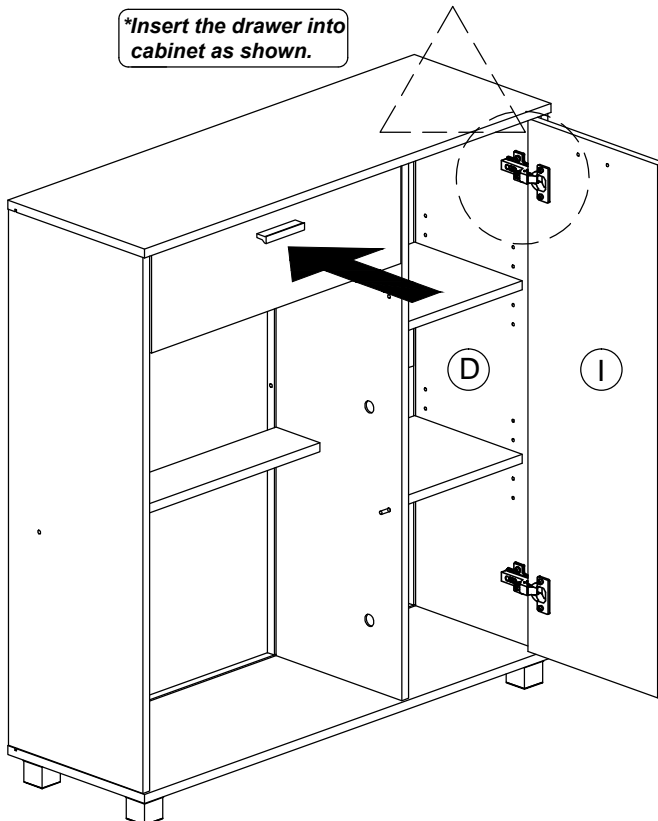

***Attach 2pcs Minifix Cap to panel (D) as shown.**

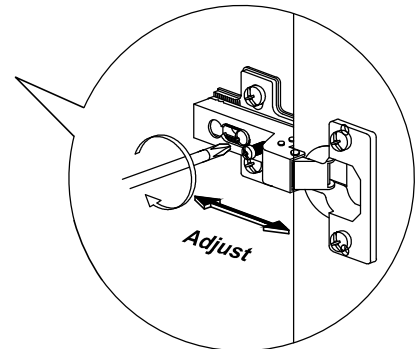
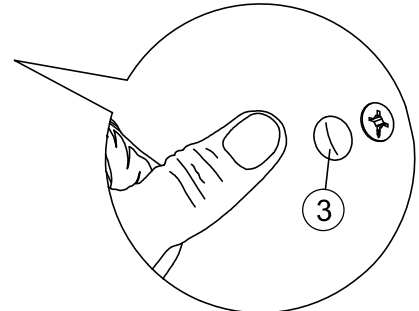

***Assemble door panels, then tighten the Hinges after the doors are adjusted to optimal position.**

Assembly Instruction

STEP 14

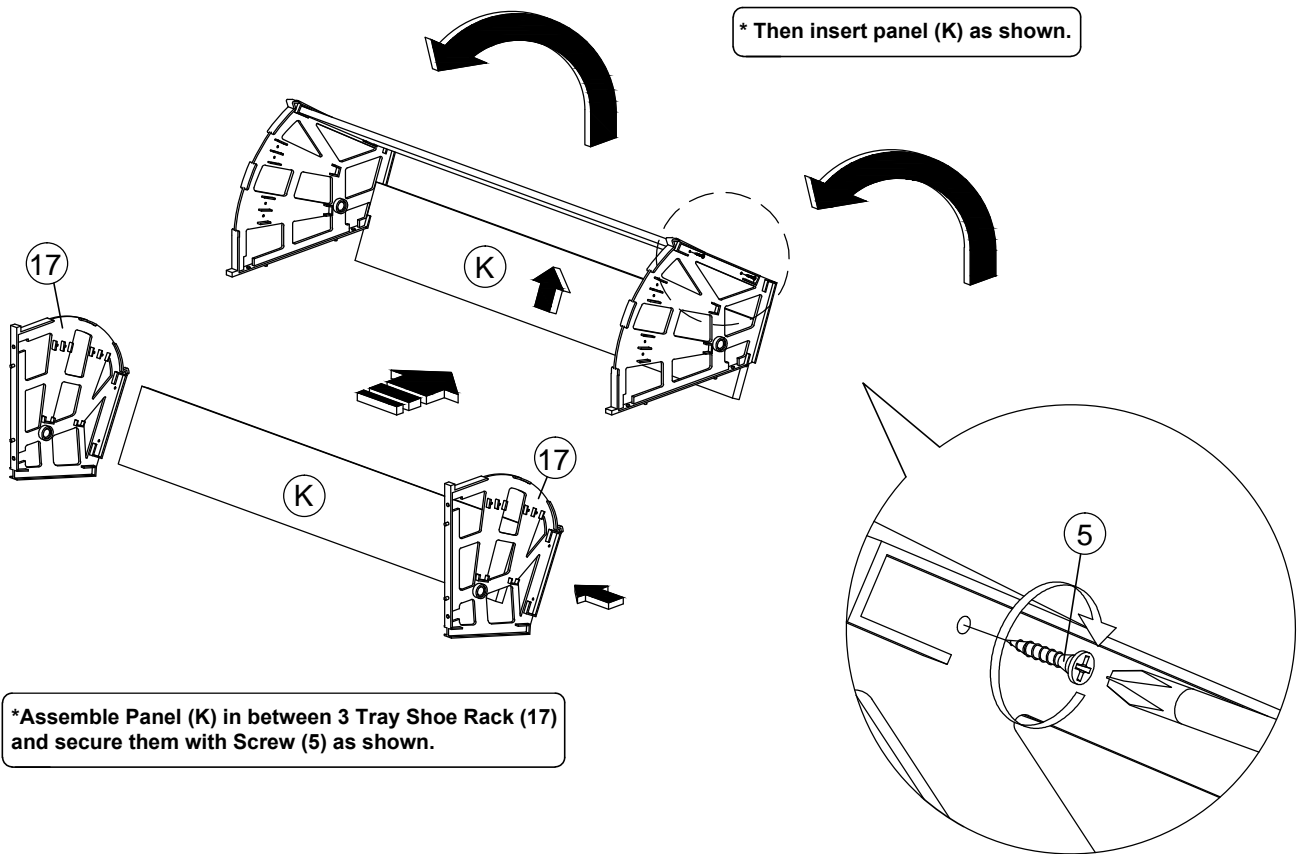

STEP 15

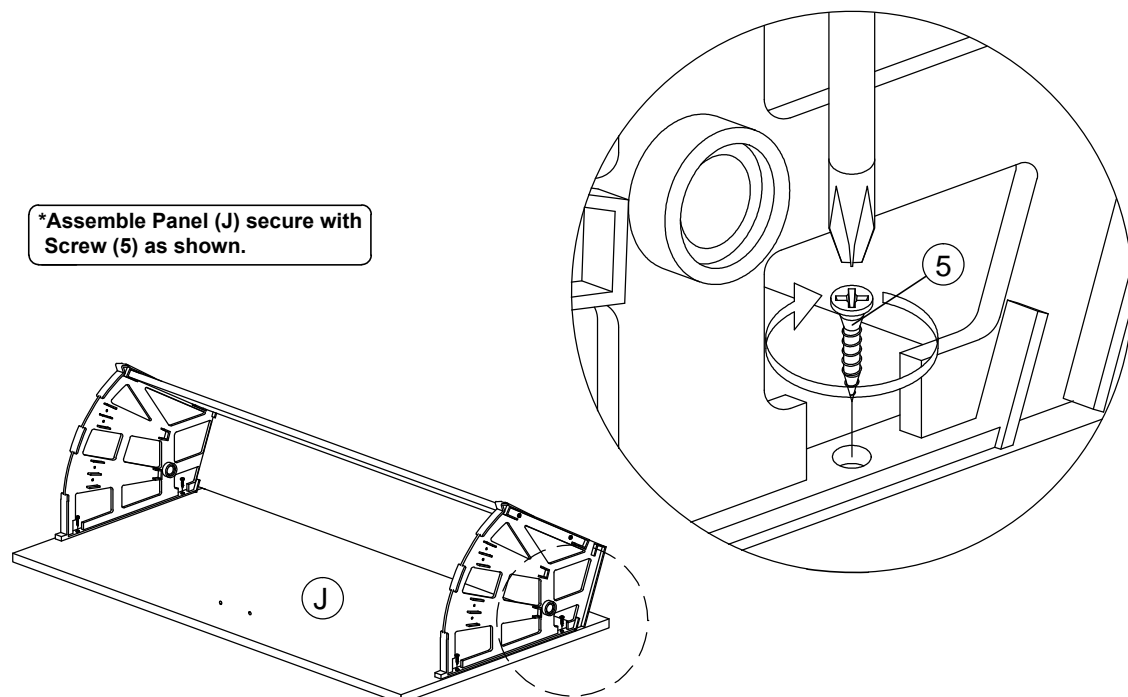

Assembly Instruction

STEP 16

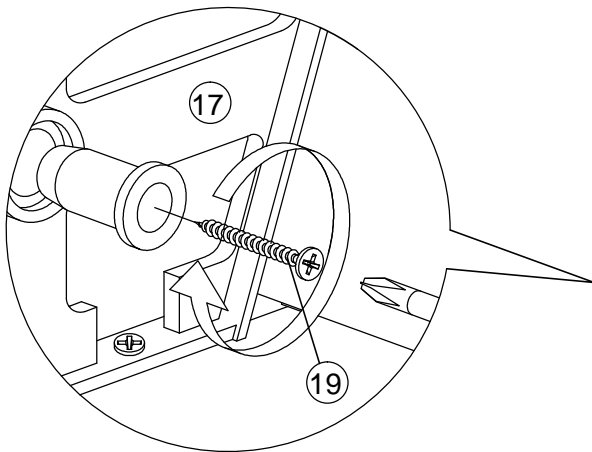

***Assemble 3 Tray Shoe Rack (17) into cabinet secure with Screw (19) as shown.**

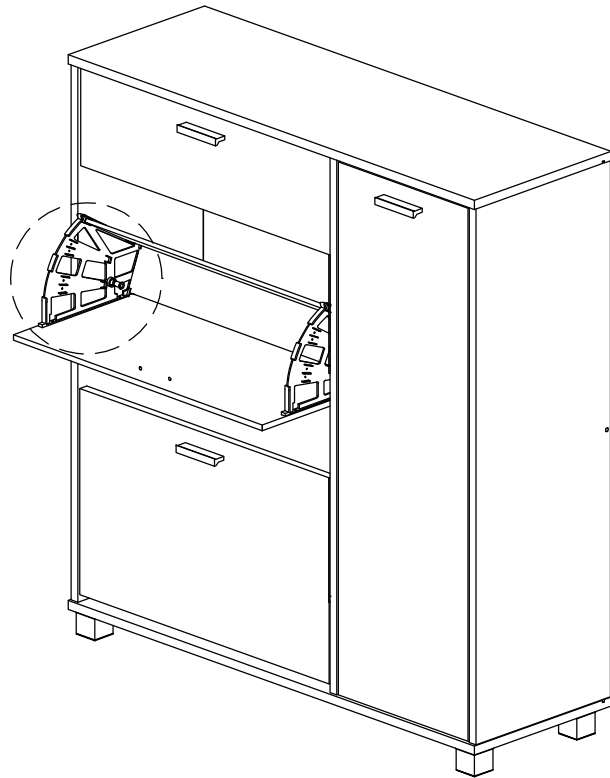

STEP 17

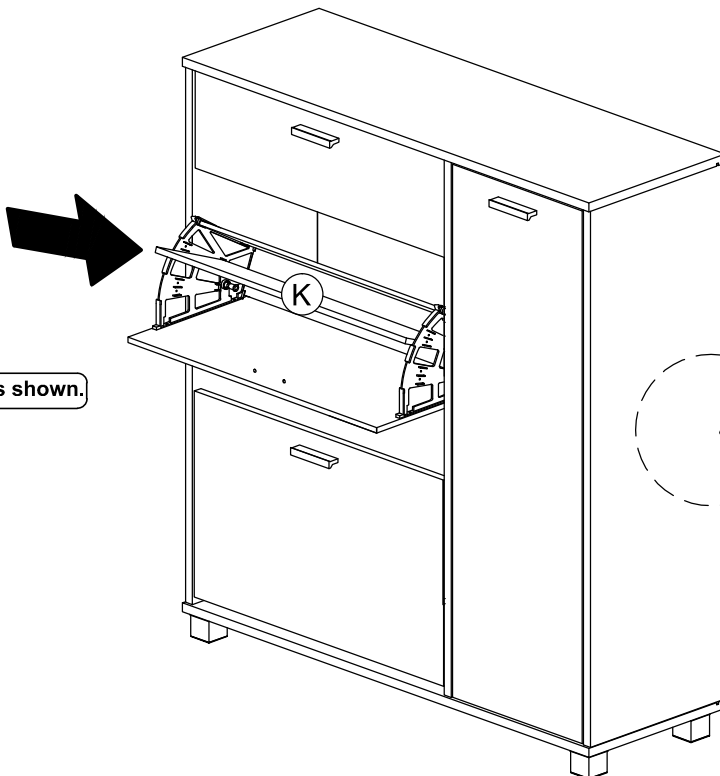

***Insert panel (K) as shown.**

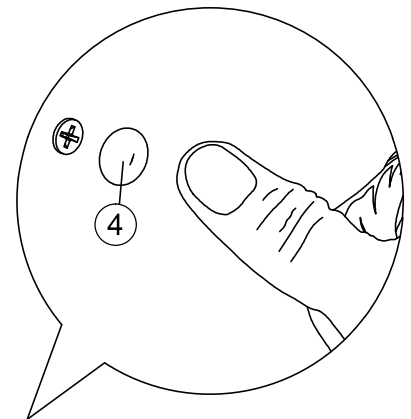

***Attach 2pcs screw cap to both side panels as shown.**