

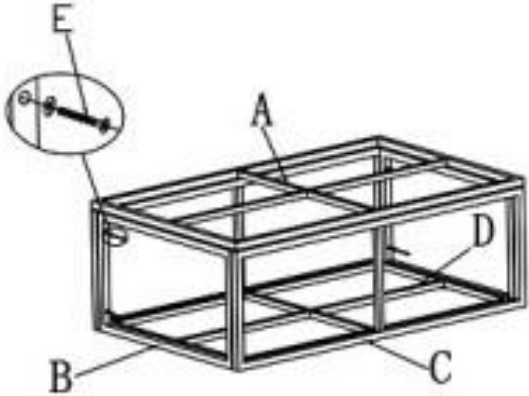

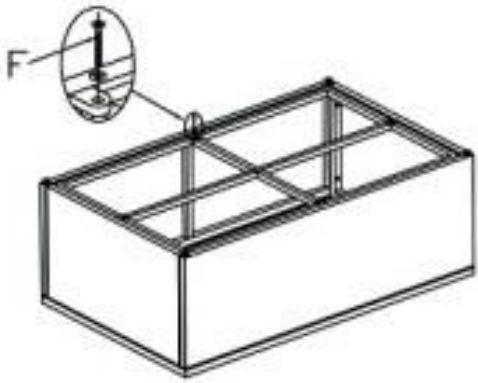







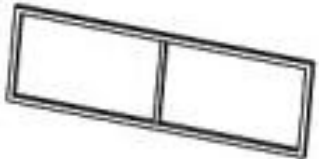



A	1		<p>①</p>  <p>②</p>  <p>③</p> 
B	2		
C	1		
D	1		
E	8	 M6*30	
F	4	 M6*15	
G	1		

A	1	
B	1	
C	1	
D	1	
E	12	 M6×30
F	12	
G	1	
H	1	

①



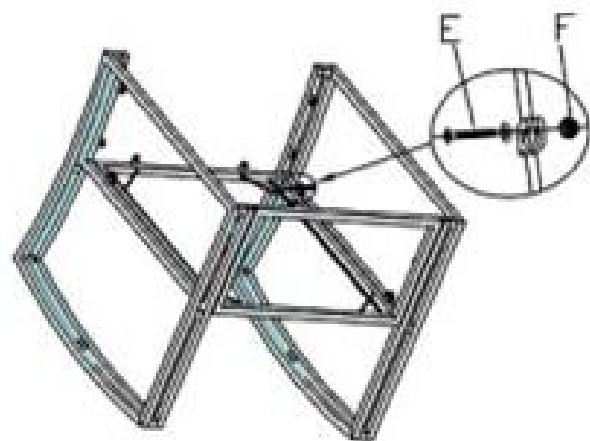

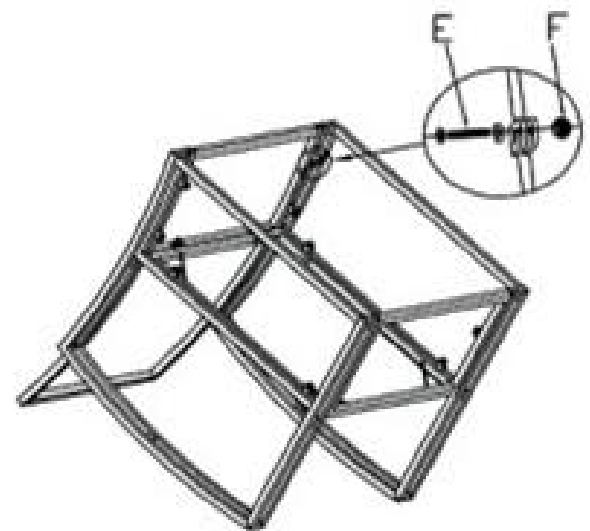

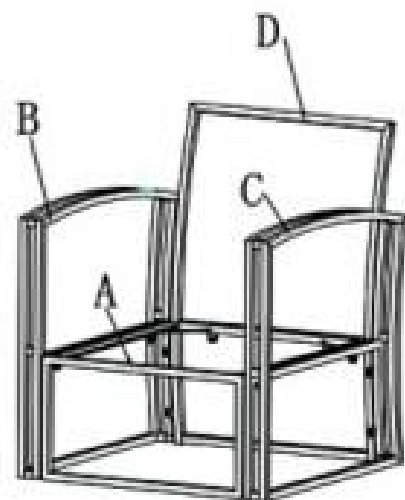

②

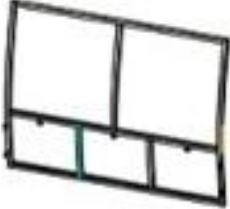

③



A	1	
B	1	
C	1	
D	1	
E	13	 M6*30
F	13	
G	1	
H	1	

①

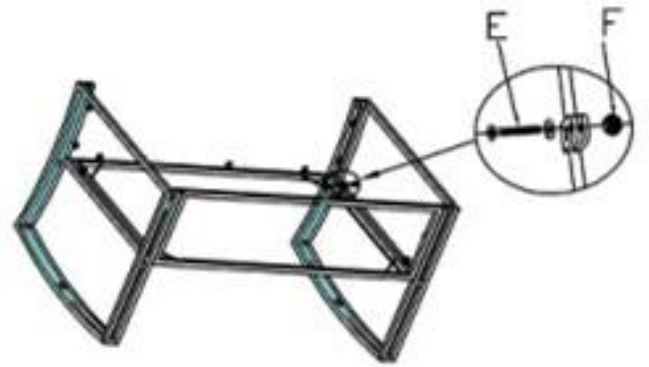

②

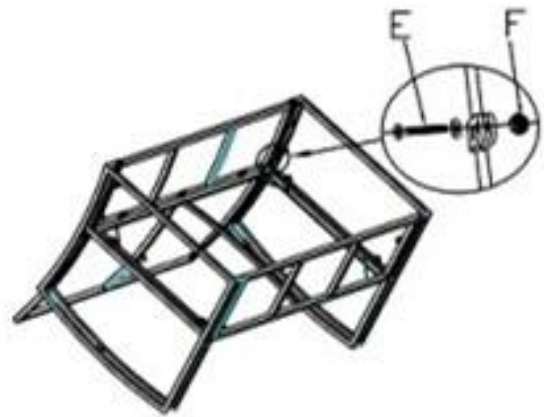

③

