



ASSEMBLY INSTRUCTION

IMPORTANT NOTE: *PLACE ALL PARTS ON A CLEAN AND SMOOTH SURFACE SUCH AS A RUG OR CARPET TO AVOID THE PARTS FROM BEING SCRATCHED.

***KINDLY FOLLOW THE ASSEMBLY INSTRUCTIONS STEP BY STEP.**

***DO NOT TIGHTEN ALL SCREWS UNTIL THE BED IS FULLY SET-UP.**

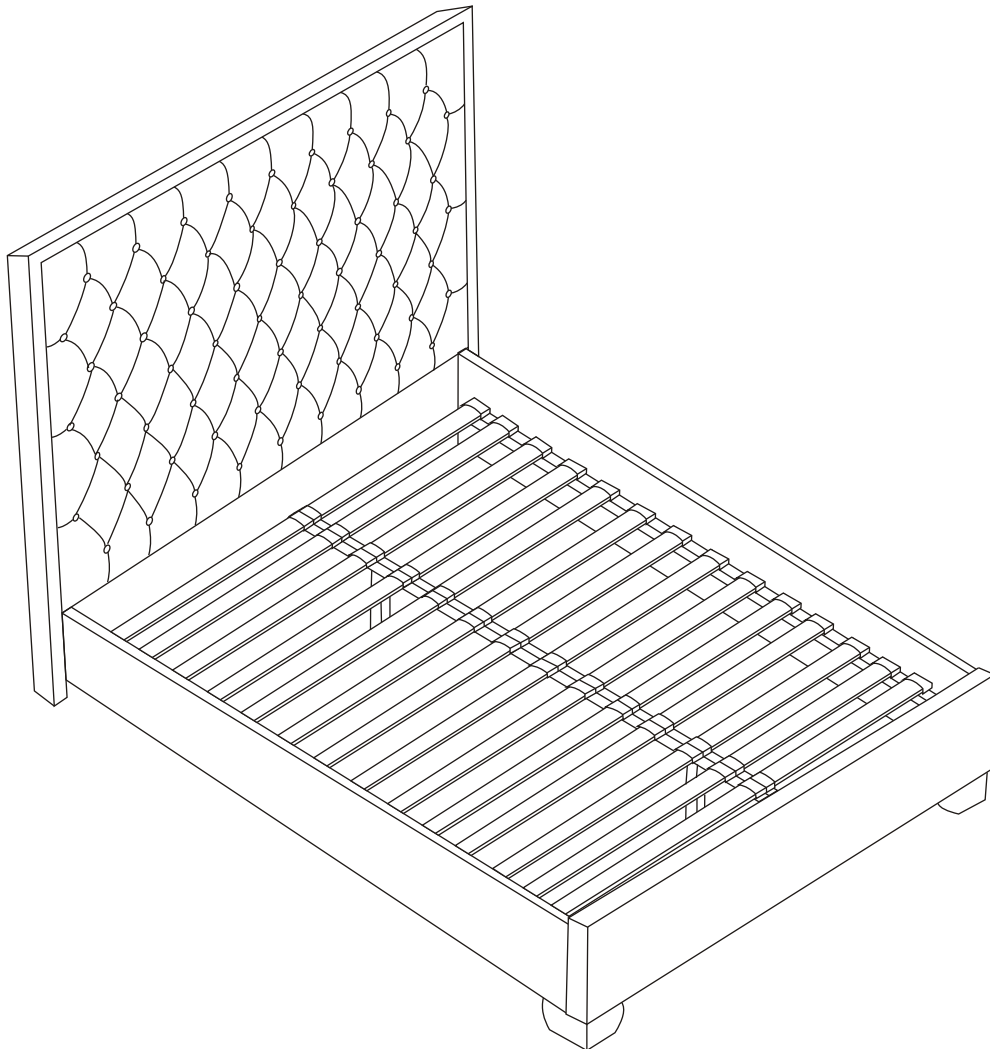

KROMA QUEEN BED

Parts list

- ① Headboard 1pc ② Footboard 1pc ③ Side Rail 2pcs ④ Double Plastic Cap 14pcs

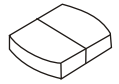
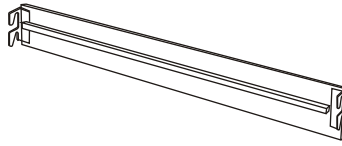
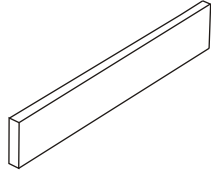
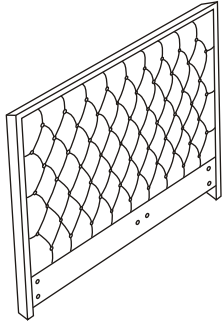



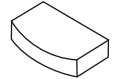
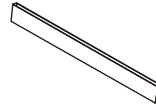
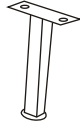



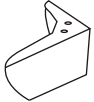

- ⑤ Centre Support Bar 1pc ⑥ Support Leg 2pcs ⑦ Slat 28pcs ⑧ Single Plastic Cap 28pcs



- ⑨ Leg 2pcs



Hardware list

<p>A Bolt M8*30mm 12pcs</p> 	<p>B Bolt M8*40mm 4pcs</p> 	<p>C Nut M8 4pcs</p> 	<p>D M8 Spring Washer 8pcs</p> 
<p>E M8 Flat Washer 8pcs</p> 	<p>F Allen Key M5 1pc</p> 	<p>G Spanner 1pc</p> 	<p>H Screw 30mm 4pcs</p> 
<p>I Screw driver (not provided)</p> 			

STEP 1 FIXING LEGS TO FOOTBOARD

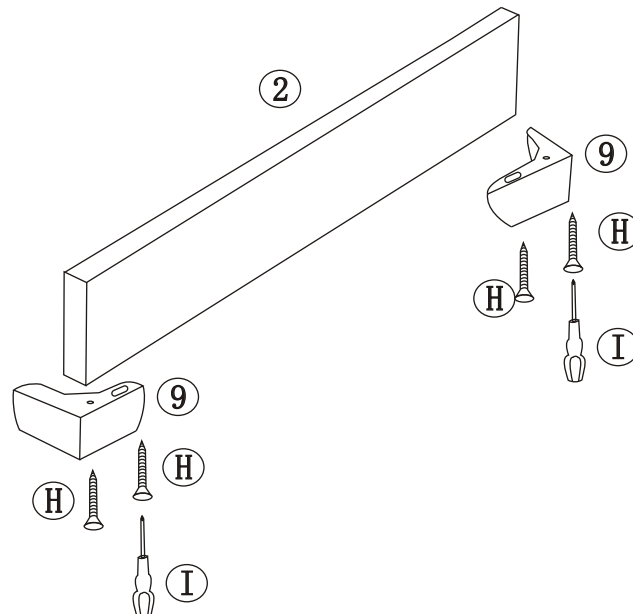

STEP 2 FIXING SUPPORT LEGS TO CENTRE SUPPORT BAR

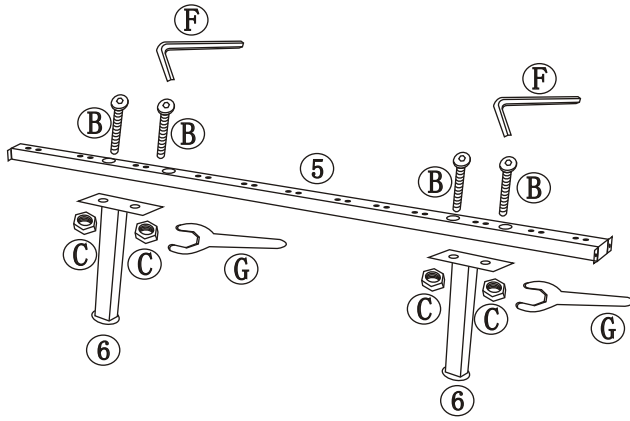

STEP 3 FIXING SIDE RAILS AND CENTRE SUPPORT BAR TO HEADBOARD AND FOOTBOARD

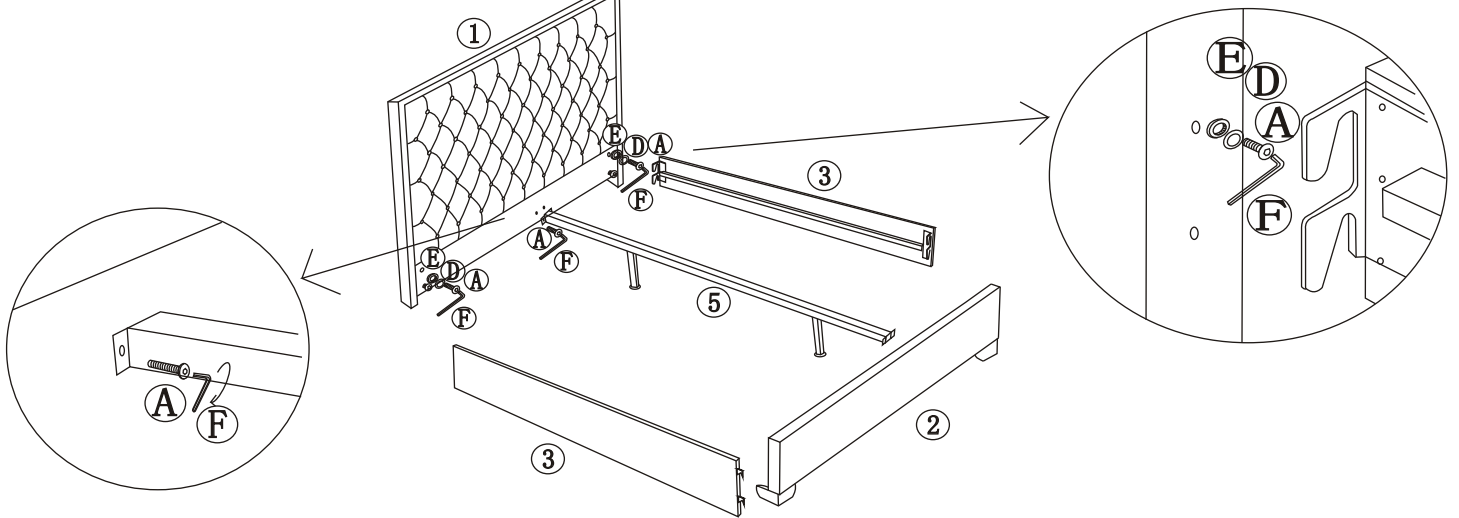

STEP 4 FIXING PLASTIC CAPS AND SLATS.

