



## ASSEMBLY INSTRUCTION

---

**IMPORTANT NOTE: \*PLACE ALL PARTS ON A CLEAN AND SMOOTH SURFACE SUCH AS A RUG OR CARPET TO AVOID THE PARTS FROM BEING SCRATCHED.**

**\*KINDLY FOLLOW THE ASSEMBLY INSTRUCTIONS STEP BY STEP.**

**\*DO NOT TIGHTEN ALL SCREWS UNTIL THE BED IS FULLY SET-UP.**

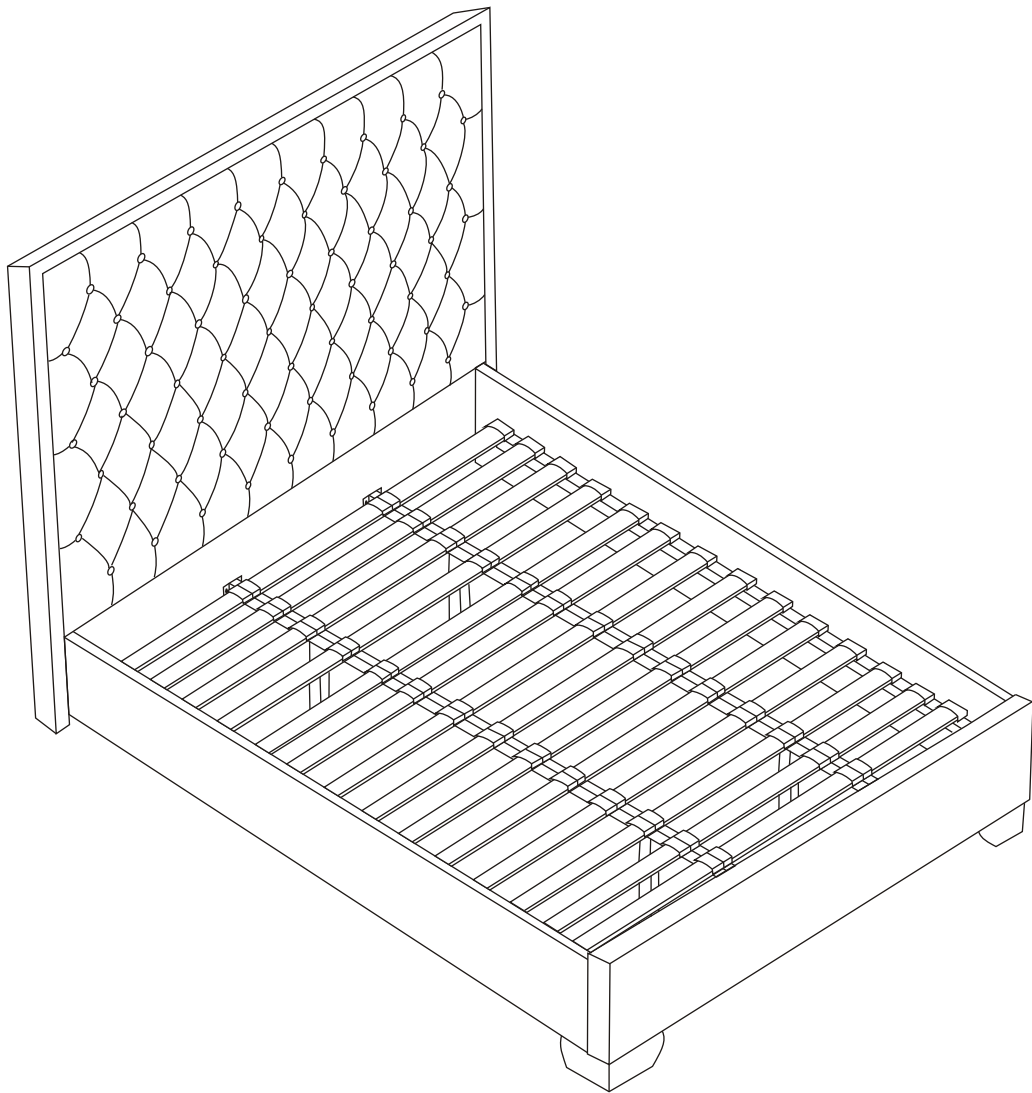

**KROMA KING BED**

# Parts list

- ① Headboard 1pc    ② Footboard 1pc    ③ Side Rail 2pcs    ④ Double Plastic Cap 28pcs

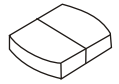
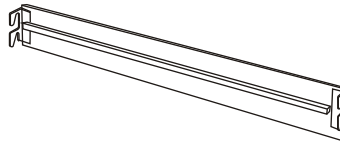
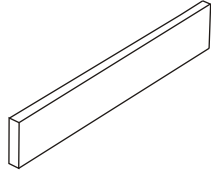
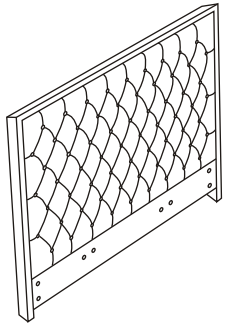



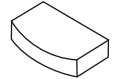
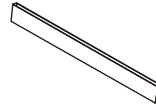
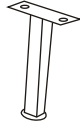

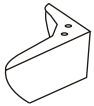

- ⑤ Centre Support Bar 2pc    ⑥ Support Leg 4pcs    ⑦ Slat 42pcs    ⑧ Single Plastic Cap 28pcs



- ⑨ Leg 2pcs

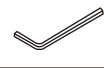
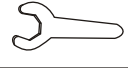

# Hardware list

<p>A Bolt M8*30mm 16pcs</p> 	<p>B Bolt M8*40mm 8pcs</p> 	<p>C Nut M8 8pcs</p> 	<p>D M8 Spring Washer 8pcs</p> 
<p>E M8 Flat Washer 8pcs</p> 	<p>F Allen Key M5 1pc</p> 	<p>G Spanner 1pc</p> 	<p>H Screw 30mm 4pcs</p> 
<p>I Screw driver (not provided)</p> 			

## STEP 1 FIXING LEGS TO FOOTBOARD

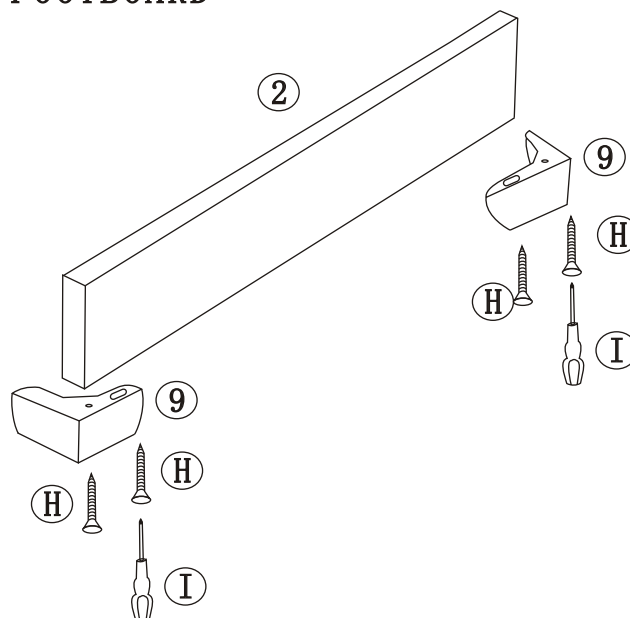

STEP 2 FIXING SUPPORT LEGS TO CENTRE SUPPORT BAR

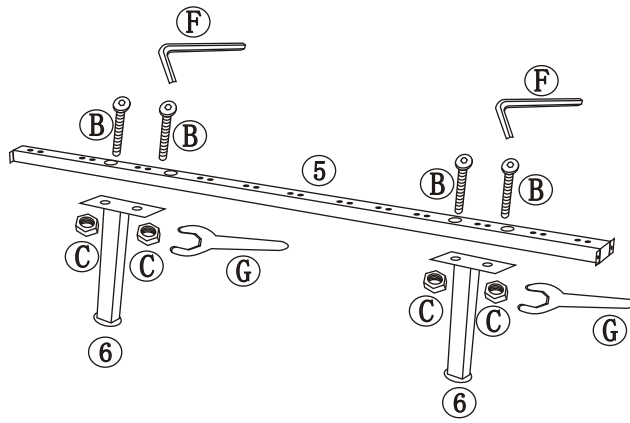

STEP 3 FIXING SIDE RAILS AND CENTRE SUPPORT BAR TO HEADBOARD AND FOOTBOARD

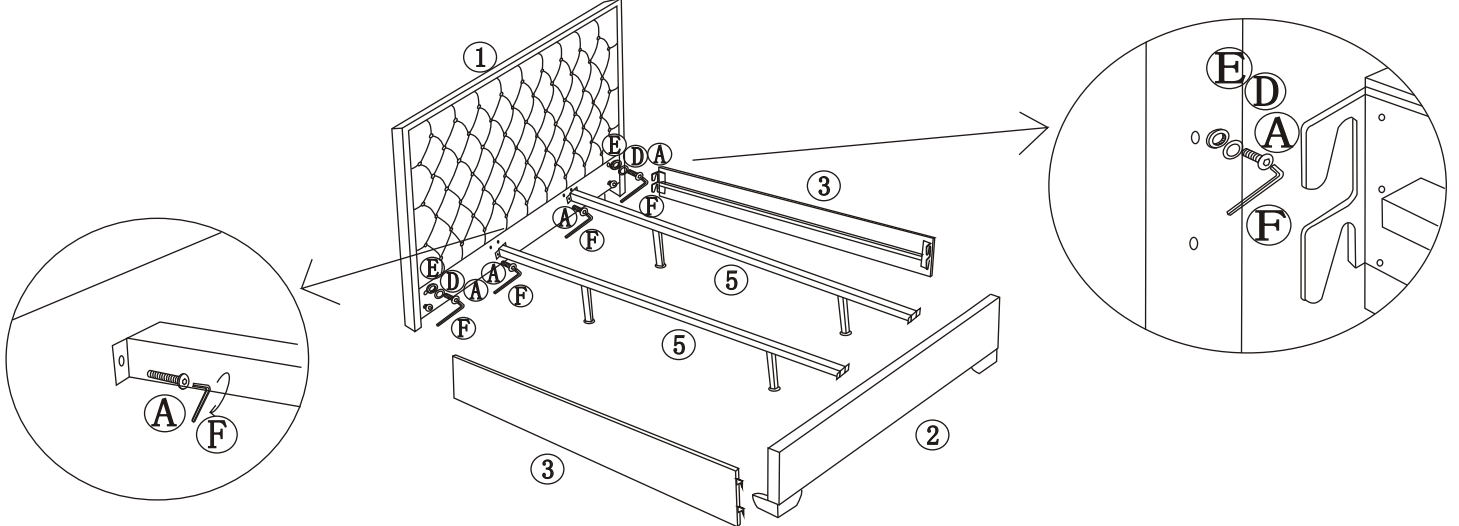

STEP 4 FIXING PLASTIC CAPS AND SLATS.

