





ASSAMBLY INSTRUCTION

MODEL: FALLABELLA PARSON

- Important note:
- Place all wooden part on a clean and smooth surface such as rug or carpet to avoid the part from being scratch.
 - Please follow the assembly instruction step by step.
 - Do not tighten all screw until the chair is fully set-up.

Hardware List			
No	Description		Qty
A	JCBC M6 x 50		12 pcs
B	Spring Washer		12 pcs
C	CSK M4 x 32mm		6 pcs
D	Wood Dowel		12 pcs
E	Allen Key		1 pcs



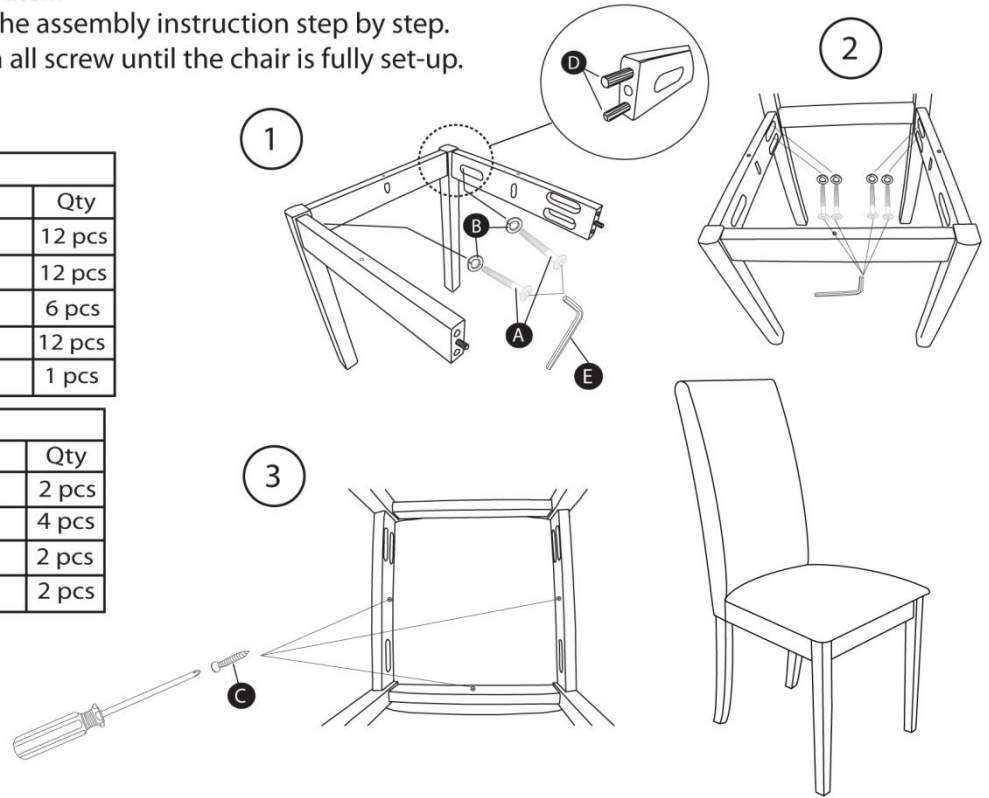

Part List		
No	Description	Qty
1	Back Rest	2 pcs
2	Side Rail	4 pcs
3	Front Leg	2 pcs
4	Wooden Slat / Cushion	2 pcs



ASSAMBLY INSTRUCTION

MODEL: FALLABELLA PARSON

- Important note:
- Place all wooden part on a clean and smooth surface such as rug or carpet to avoid the part from being scratch.
 - Please follow the assembly instruction step by step.
 - Do not tighten all screw until the chair is fully set-up.

Hardware List			
No	Description		Qty
A	JCBC M6 x 50		12 pcs
B	Spring Washer		12 pcs
C	CSK M4 x 32mm		6 pcs
D	Wood Dowel		12 pcs
E	Allen Key		1 pcs

Part List		
No	Description	Qty
1	Back Rest	2 pcs
2	Side Rail	4 pcs
3	Front Leg	2 pcs
4	Wooden Slat / Cushion	2 pcs

