



Assembly instructions

WI 6654 - EDD8VM-M B -W1PS/PG3

		Tools: 
---	---	---

Include:

8 pcs	8 pcs	1 pcs
		



Component List:

A. Table Top

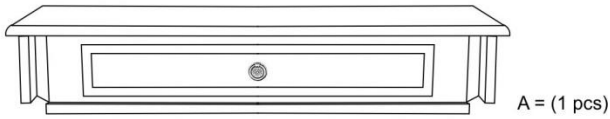

C.Shelf

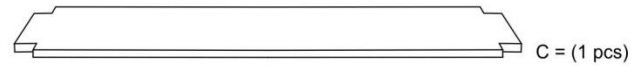

B. Legs

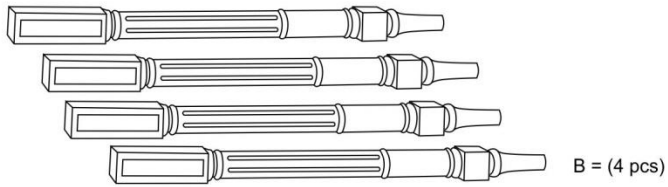

Assembly:

①

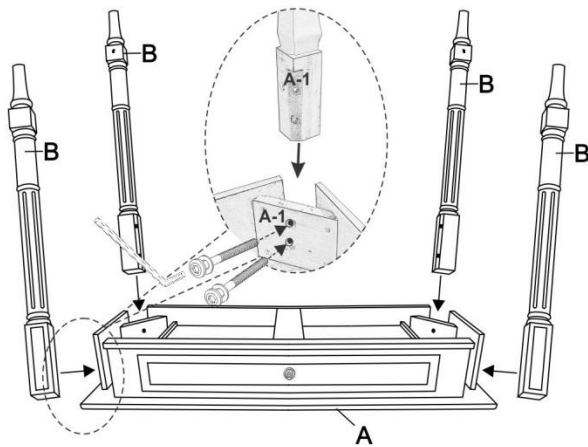

②

