















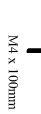

ASSEMBLY INSTRUCTION

MODEL: CF 8956 (5')

A		1 pc
B		1 pc
C		2 pcs
D		4 pcs
E		1 pc
F		2 pcs
G		28 pcs
H		14 pcs
I		28 pcs
J		2 pcs
K		4 pcs
L		1 pc
M		2 pcs
N		4 pcs
O		8 pcs
P		8 pcs
Q		2 pcs

Step 1: Tighten the legs (D) to both headboard (A) and footboard (B) as shown.

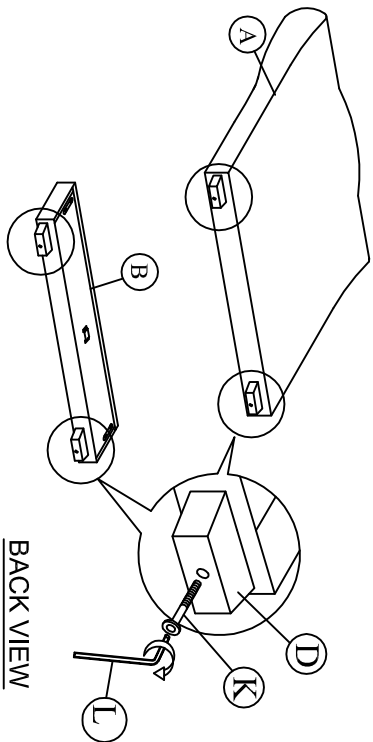

Step 2: Attach side rail to headboard and footboard and tighten the screws & flat washers to the headboard and footboard.

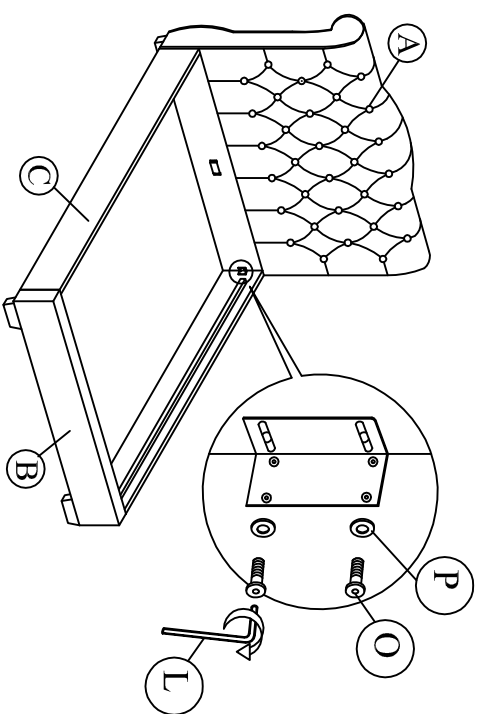

Step 3: Attach the support legs (F) to the center rail (E) of the bed as shown.

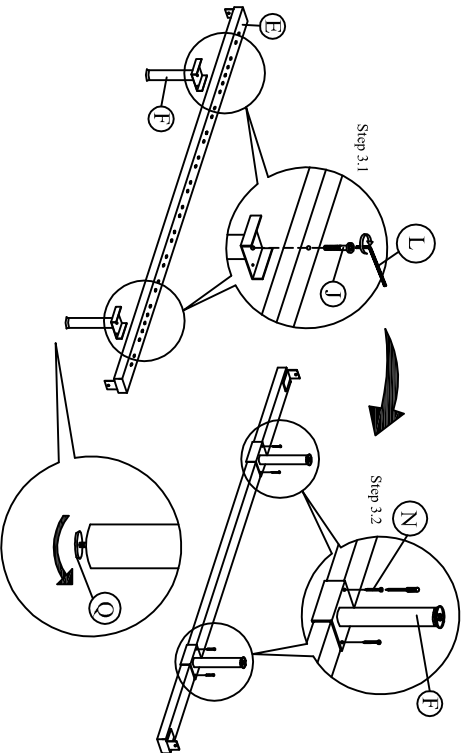

Step 4: Slide the center rail (E) to the headboard (A) and footboard (B). Tighten screws (M) using screw driver (not included) to the headboard (A) and footboard (B).

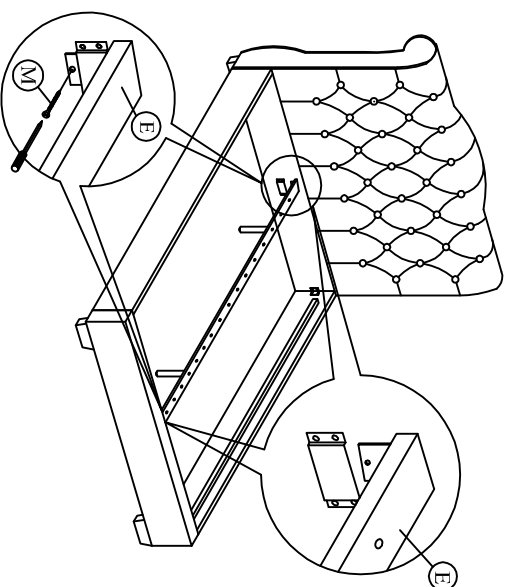

Step 5: Assembly of the slat holders with LVL slats as shown.

