

MODEL : BBT 6496 HB (W1560 x H605 x T65mm)

ASSEMBLY INSTRUCTIONS

Read this instruction carefully. See hardware and furniture part list for guidance. Be sure all parts are complete, before you assemble. Place all wooden furniture parts on a clean and flat soft surface to prevent from being scratched. Follow the figure to start assembling.

PART LIST		
ITEM	DESCRIPTION	QTY
A	HEADBOARD	1 PC
B	SUPPORT BOARD	2 PCS

PART LIST		
ITEM	DESCRIPTION	QTY
1	JCBB BOLT M8 x 45mm	4 PCS
2	M8 FLAT WASHER	4 PCS
3	M5 ALLEN KEY	1 PC

CAUTIONS :

1. Do not FULLY - TIGHTEN the nut or nut bolt until all nut or bolt is ready assembled.
2. Do not OVER - TIGHTEN the nut or bolt to avoid causing damages to the thread.
3. Keep all hardware parts out of reach of children.

NOTE : THE LIST AND QUANTITY SHOWN ARE FOR 1 UNIT ASSEMBLY.

STEP 1

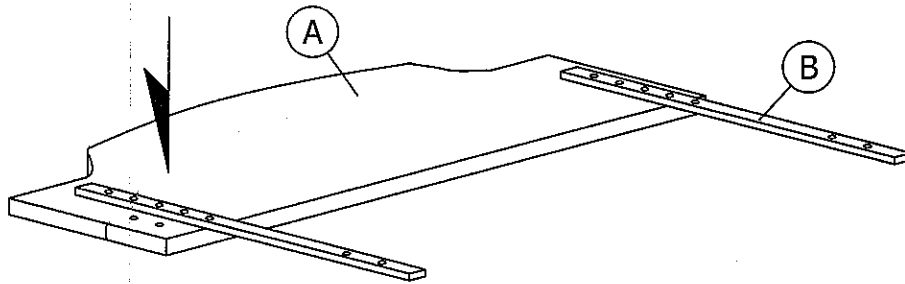

Align support board fixing holes over headboard fixing holes according to your desire height.

STEP 2

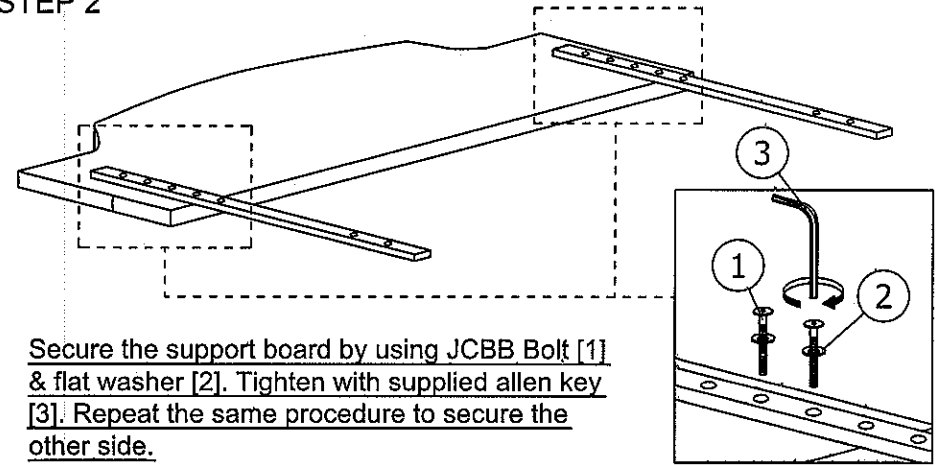

Secure the support board by using JCBB Bolt [1] & flat washer [2]. Tighten with supplied allen key [3]. Repeat the same procedure to secure the other side.

STEP 3

Your headboard assembly is complete.
Note: Hardware may loose over time. Periodically check that all connections are tight.

